

T₃U Rim Series

Table Top Tilt Up Boxes

FSR

Metal Products Group



T3U-1

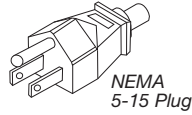

NEMA
5-15 Plug



T3U-2

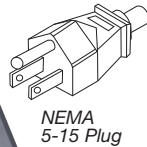

NEMA
5-15 Plug



T3U-3

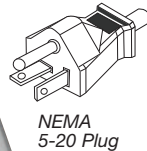

NEMA
5-20 Plug

Introducing FSR's expanded line of table box solutions...

The T₃U RIM Series (Table Top Tilt Up) table boxes.

Designed expressly for applications requiring multiple access boxes within the same table, the FSR T₃U RIM Series handles data, power, and AV connections in a low profile box.

You can match almost any decor with the T₃U RIM Series cover finish selection. Colors include Black, brushed Brass, brushed Bronze or brushed Nickel. The T₃U RIM Series easily installs in any table surface with thickness ranging from a minimum .75" to a maximum of 2.75". In the open position, the T₃U RIM Series cover protrudes a mere 1.19" from the table top. Under the table, the T₃U RIM Series extends only 4.25" from the table top surface.

The FSR T₃U RIM Series offer a variety of connection schemes through the use of interchangeable snap in connectors and mounting plates. This allows the plates to be populated by the installer and can be changed as the need arises. FSR offers a complete line of connectors and plates to satisfy most installation requirements. (See options on the following pages).

NOTE: T₃U-1 and T₃U-2 models have a 6' NEMA 5-15 SJ cordset. The T₃U-3 model has a 9' NEMA 5-20 SJ cordset.

T3U-1

T3U-1 Connector Plate View

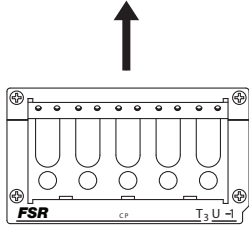
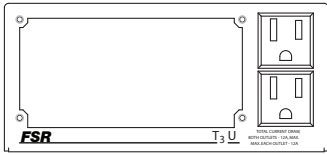

T3U-1-CP

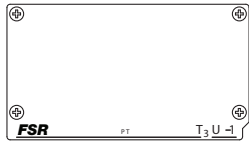

T3U-1-PT

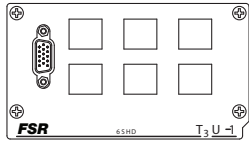

T3U-1-6SHD

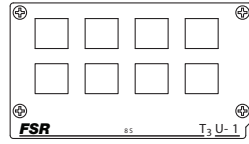

T3U-1-8S

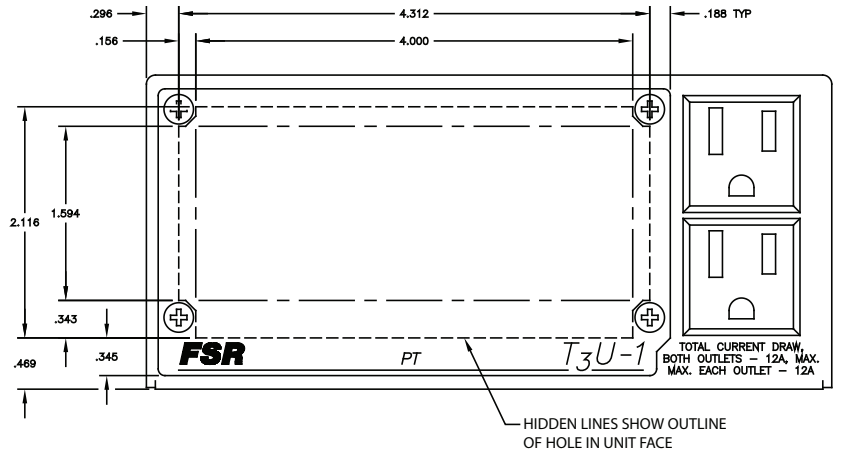

T3U-2 Connector Plate View

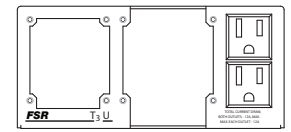

Left Plate Options

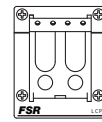

T3U-2-LCP

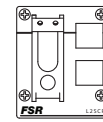

T3U-2-L2SCP

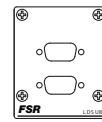

T3U-2-LDSUB



T3U-2-LPT

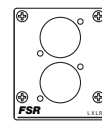

T3U-2-LXLR

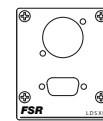

T3U-2-LDSXL
No Connectors

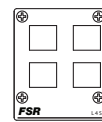

T3U-2-L4S

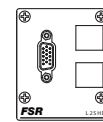

T3U-2-L2SHD

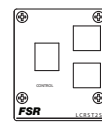

T3U-2-LCRST2S

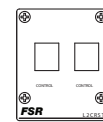

T3U-2-L2CRST

Right Plate Options

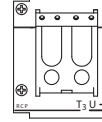

T3U-2-RCP

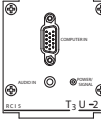

T3U-2-RCIS

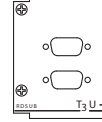

T3U-2-RDSUB
No Connectors



T3U-2-RPT
No Connectors

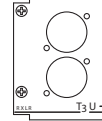

T3U-2-RXLR
No Connectors

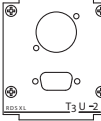

T3U-2-RDSXL
No Connectors

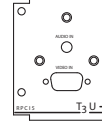

T3U-2-RPCIS

T3U-2

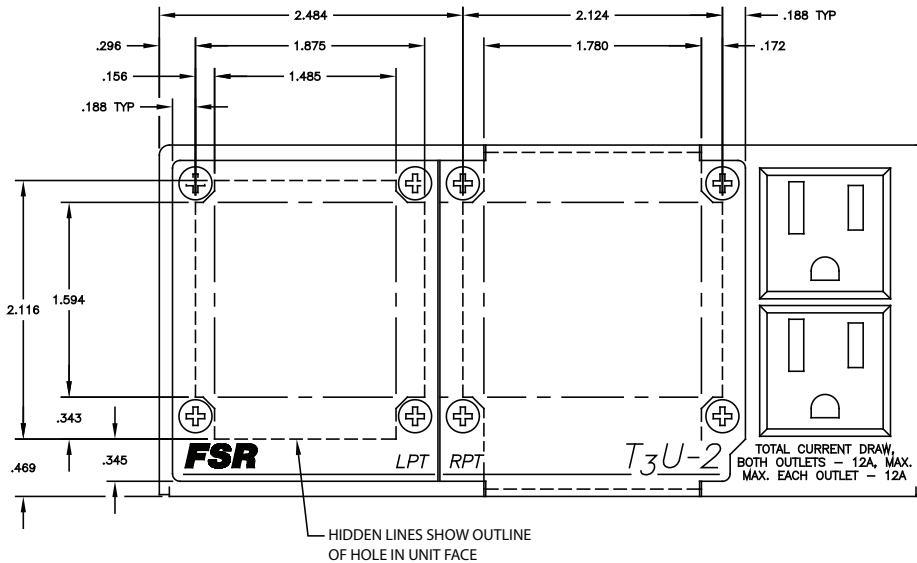

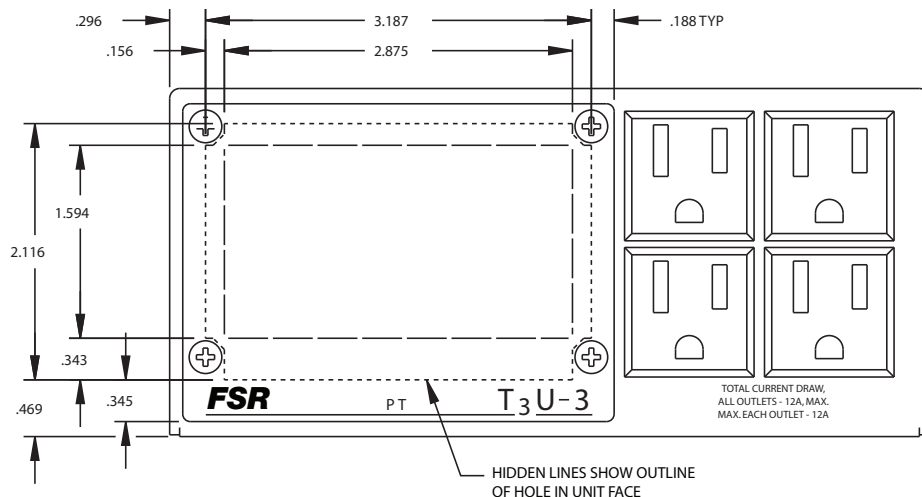
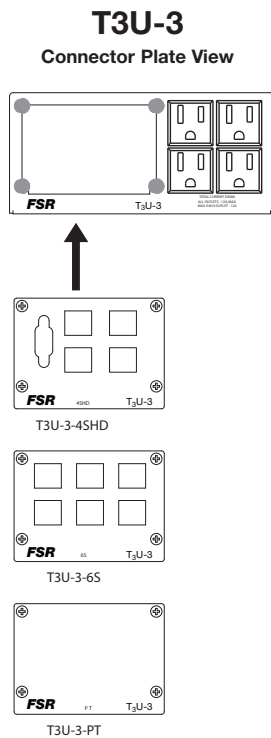

SNAP IN CONNECTORS AVAILABLE (ALL MODELS)

SNAP IN CONNECTOR ORDERING DETAILS

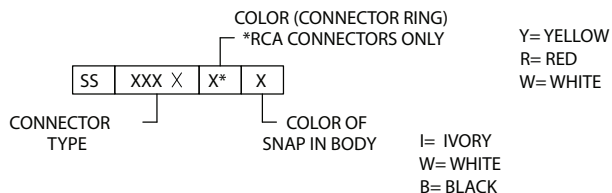

ORDERING INFORMATION

MODEL	FINISH	ACCEPTS <i>(see selection illustrations)</i>
T3U-1R-BLK	BLACK	ONE T3U-1 INSERT
T3U-1R-BRS	BRUSHED BRASS	ONE T3U-1 INSERT
T3U-1R-BRZ	BRUSHED BRONZE	ONE T3U-1 INSERT
T3U-1R-NKL	BRUSHED NICKEL	ONE T3U-1 INSERT
T3U-2R-BLK	BLACK	ONE SET OF T3U-2 LEFT AND RIGHT INSERT PLATES
T3U-2R-BRS	BRUSHED BRASS	ONE SET OF T3U-2 LEFT AND RIGHT INSERT PLATES
T3U-2R-BRZ	BRUSHED BRONZE	ONE SET OF T3U-2 LEFT AND RIGHT INSERT PLATES
T3U-2R-NKL	BRUSHED NICKEL	ONE SET OF T3U-2 LEFT AND RIGHT INSERT PLATES
T3U-3R-BLK	BLACK	ONE T3U-3 INSERT
T3U-3R-BRS	BRUSHED BRASS	ONE T3U-3 INSERT
T3U-3R-BRZ	BRUSHED BRONZE	ONE T3U-3 INSERT
T3U-3R-NKL	BRUSHED NICKEL	ONE T3U-3 INSERT

TYPICAL INSTALLATION FOR ALL THREE

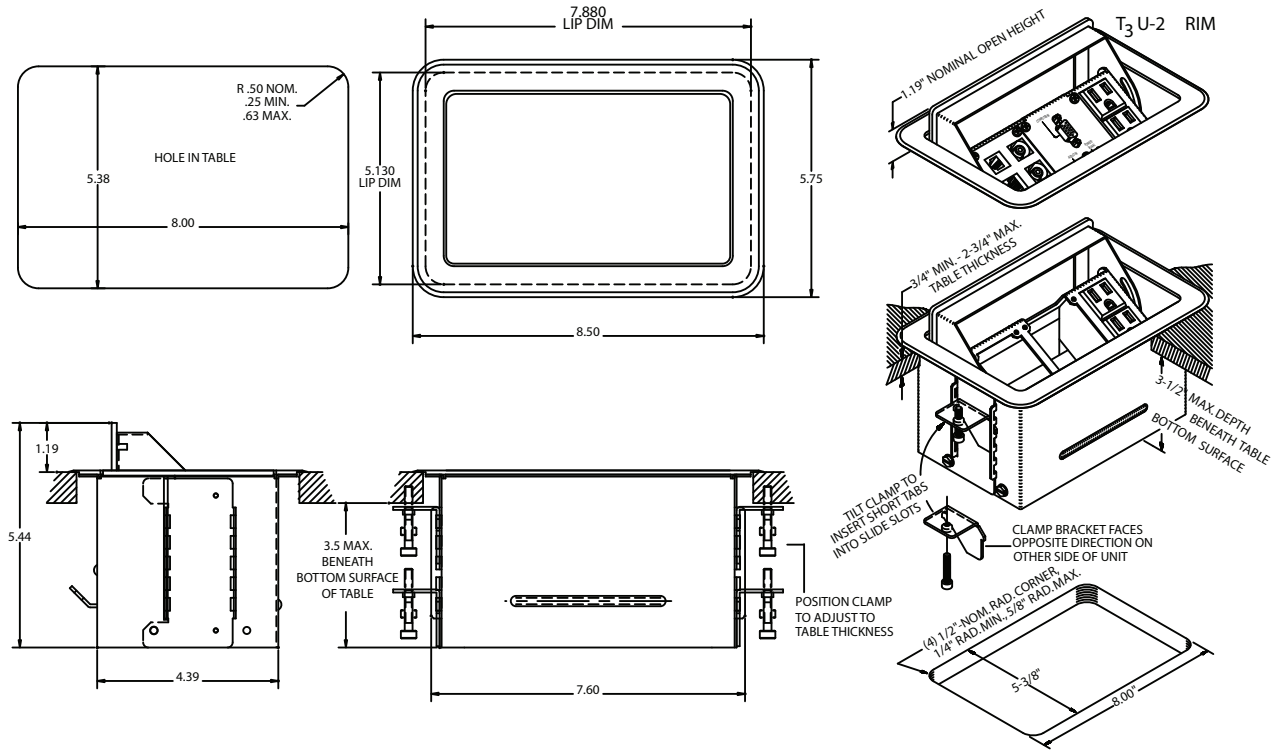

NOTE: T3U-1 and T3U-2 models have a 6' NEMA 5-15 SJ cordset. The T3U-3 model has a 9' NEMA 5-20 SJ cordset.

SIMILAR FSR PRODUCT OFFERINGS

The T3-PCI and T3-AC2 are perfect table boxes for single users, where convenient access to network drops, ac power sources and video/audio displays are required. The small footprint provides an unobtrusive complement to any decor.



T3-AC2



T3-PC1



PRÉSENCE

Québec Montréal
 Tél. : (418) 681-2470 Tél. : (514) 871-1994
 www.presence.qc.ca

Specifications are subject to change without notice.

